



# Cambridge IGCSE™

CANDIDATE  
NAME

--

CENTRE  
NUMBER

--	--	--	--	--

CANDIDATE  
NUMBER

--	--	--	--



**MATHEMATICS**

**0580/11**

Paper 1 (Core)

**October/November 2022**

**1 hour**

You must answer on the question paper.

You will need: Geometrical instruments

## INSTRUCTIONS

- Answer **all** questions.
- Use a black or dark blue pen. You may use an HB pencil for any diagrams or graphs.
- Write your name, centre number and candidate number in the boxes at the top of the page.
- Write your answer to each question in the space provided.
- Do **not** use an erasable pen or correction fluid.
- Do **not** write on any bar codes.
- You should use a calculator where appropriate.
- You may use tracing paper.
- You must show all necessary working clearly.
- Give non-exact numerical answers correct to 3 significant figures, or 1 decimal place for angles in degrees, unless a different level of accuracy is specified in the question.
- For  $\pi$ , use either your calculator value or 3.142.

## INFORMATION

- The total mark for this paper is 56.
- The number of marks for each question or part question is shown in brackets [ ].

This document has **12** pages. Any blank pages are indicated.

1 Write the number two million eight hundred and forty thousand three hundred and twenty-seven in figures.

..... [1]

2

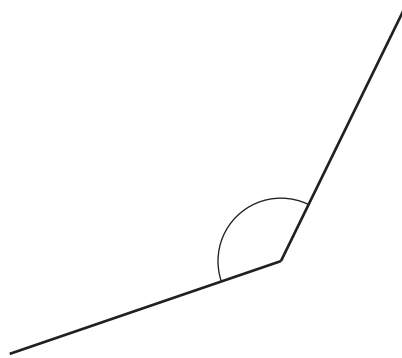

Write down the mathematical name of this type of angle.

..... [1]

3



(a) Measure the length of this line in millimetres.

..... mm [1]

(b) Draw a line perpendicular to this line.

[1]

4 In triangle  $PQR$ ,  $PR = 5$  cm and  $QR = 4$  cm.

**Using a ruler and compasses only**, construct triangle  $PQR$ .  
 Leave in your construction arcs.  
 The side  $PQ$  has been drawn for you.



[2]

5 Write down a common multiple of 18 and 24.

..... [1]

6 Write 32 cm as a fraction of 2 m.  
 Give your answer in its simplest form.

..... [2]

7 The temperature, in  $^{\circ}\text{C}$ , is recorded at the same time in six cities.

London	Helsinki	Oslo	Paris	Madrid	Berlin
6	-2	-5	7	9	2

(a) Which city has the coldest temperature?

..... [1]

(b) What is the difference in temperature between Helsinki and Paris?

.....  $^{\circ}\text{C}$  [1]

8

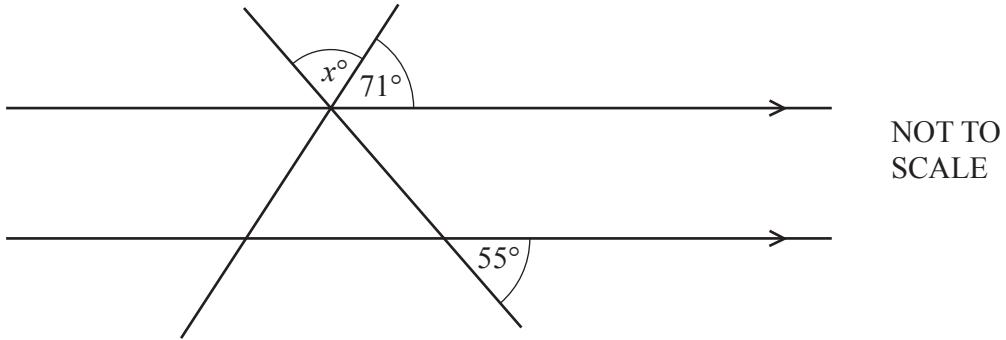

The diagram shows two straight lines intersecting two parallel lines.

Find the value of  $x$ .

$x = \dots\dots\dots$  [2]

9 Divide \$200 in the ratio 7 : 3.

\$ \dots\dots\dots , \$ \dots\dots\dots [2]

10 The birth weights, in kg, of 11 babies are recorded.

- 2.1 1.6 2.7 4.2 4.0 2.2 3.1 1.7 2.6 3.3 3.7

(a) Complete the stem-and-leaf diagram to show this information.

1	
2	
3	
4	

Key: 2|1 represents 2.1 kg

[2]

(b) Find the median.

\dots\dots\dots kg [1]

- 11 Victoria records the colour of each of 240 cars leaving a car park. Some of this information is shown in the pie chart.

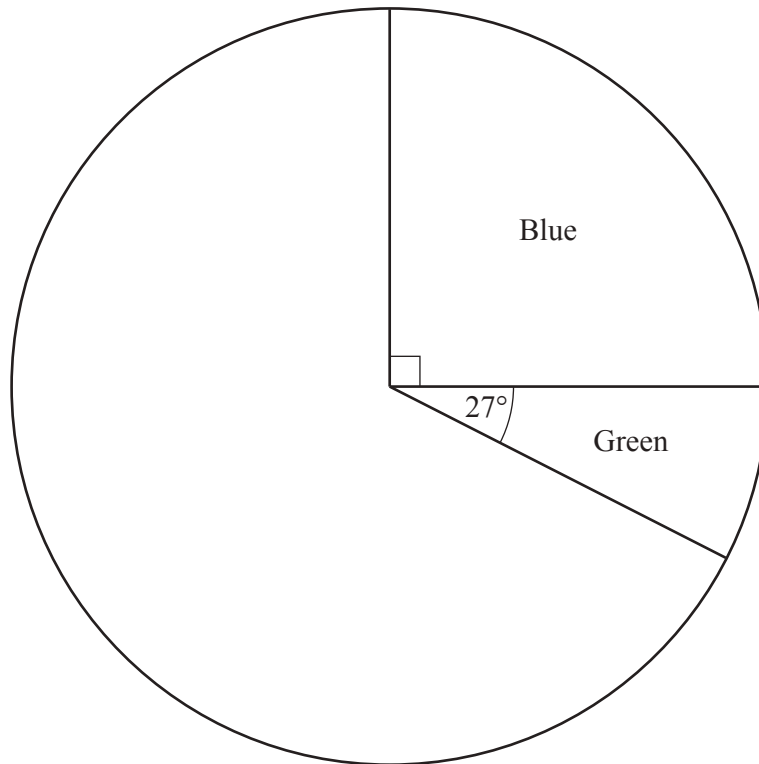

- (a) Show that 60 cars are blue.

[1]

- (b) The rest of the cars are either red or white.  
110 cars are red.

Complete the pie chart to show this information.

[2]

- 12 The price of a computer is \$520.  
This price is reduced by 15% in a sale.

Work out the sale price.

\$ ..... [2]

- 13 **Without using a calculator**, work out  $\frac{1}{3} + \frac{5}{6}$ .

You must show all your working and give your answer as a mixed number in its simplest form.

..... [2]

- 14 Mario tests new cars.  
The probability that a car is faulty is 0.04 .

(a) Find the probability that a car is not faulty.

..... [1]

(b) In one week Mario tests 850 cars.

Find the number of cars that are expected to be faulty.

..... [2]

- 15 A café sells 330 sandwiches.  
This is  $\frac{11}{14}$  of the sandwiches they make.

Work out the number of sandwiches the café makes.

..... [2]

- 16 (a) Complete the table of values for  $y = \frac{5}{x}$ .

$x$	-5	-4	-2.5	-2	-1		1	2	2.5	4	5
$y$	-1		-2	-2.5	-5		5	2.5	2		1

[2]

- (b) On the grid, draw the graph of  $y = \frac{5}{x}$  for  $-5 \leq x \leq -1$  and  $1 \leq x \leq 5$ .

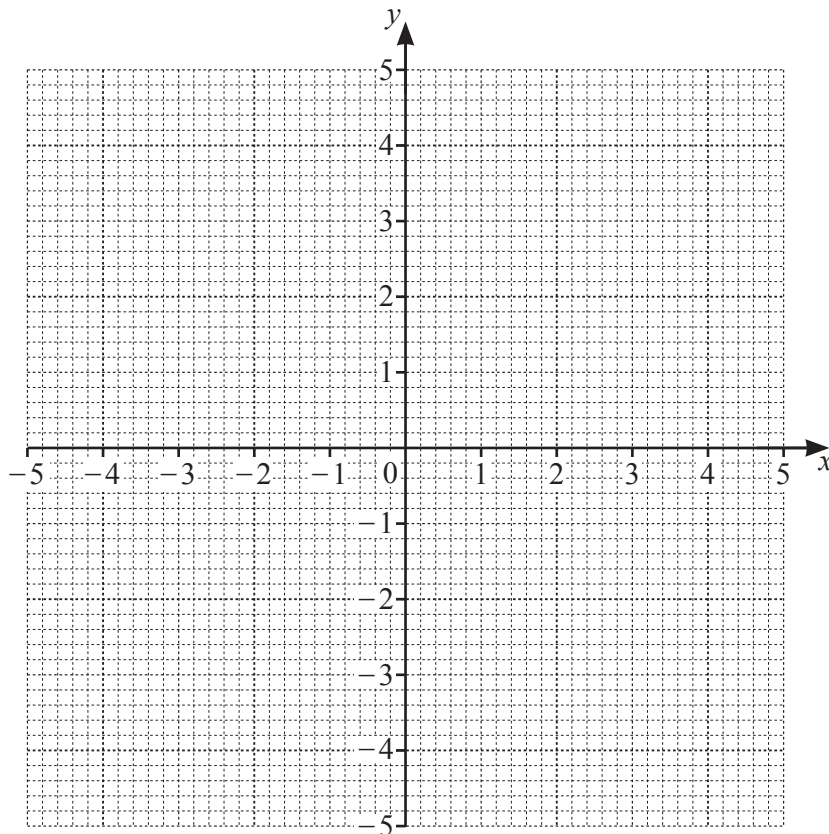

[4]

17 (a) 3, 9, 27, 81, ...

Write down the term to term rule for this sequence.

..... [1]

(b) 13, 17, 21, 25, ...

Find the  $n$ th term of this sequence.

..... [2]

18

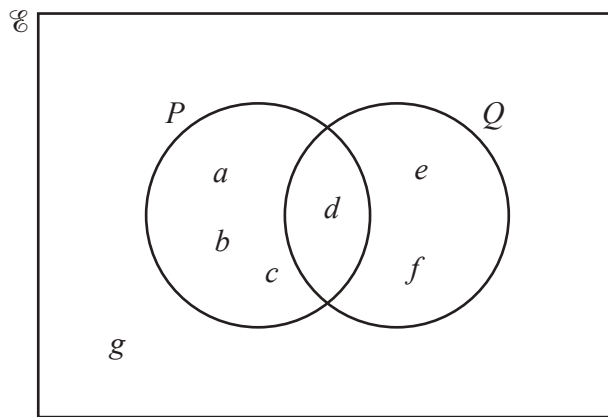

The Venn diagram shows the elements of the sets  $\mathcal{E}$ ,  $P$  and  $Q$ .

Complete the statements.

(a)  $P = \{ \dots \}$  [1]

(b)  $n(P \cup Q) = \dots$  [1]

19 The bearing of  $A$  from  $B$  is  $137^\circ$ .

Find the bearing of  $B$  from  $A$ .

..... [2]



20 (a) Write 0.00273 in standard form.

..... [1]

(b) Sam has to answer this question.

Calculate  $9306 \times 4532$ .  
Give your answer in standard form correct to 3 significant figures.

Sam writes  $42.1 \times 10^6$  as his answer to this question.

What two errors has Sam made?

Error 1 .....

Error 2 .....

[2]

21

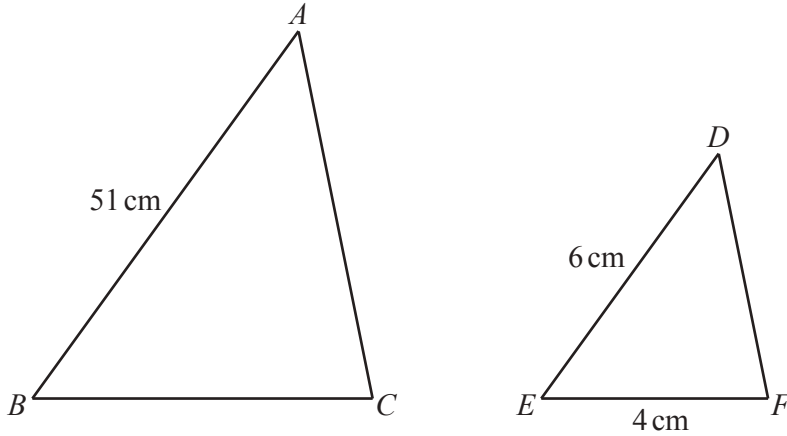

NOT TO SCALE

Triangle  $ABC$  is mathematically similar to triangle  $DEF$ .

Find  $BC$ .

$BC =$  ..... cm [2]

22

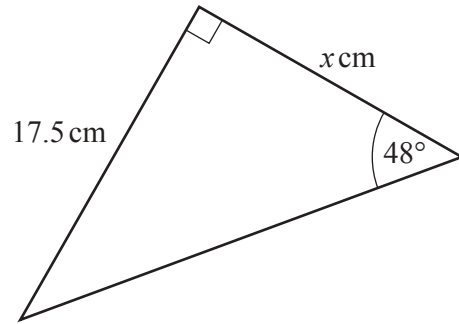
NOT TO  
SCALE

The diagram shows a right-angled triangle.

Show that the value of  $x$  is 15.8, correct to 3 significant figures.

[3]

- 23 Natalie buys 4 tomato plants and 3 pepper plants for \$9.35 .  
Samir buys 2 tomato plants and 11 pepper plants for \$16.55 .

Write down a pair of simultaneous equations and solve them to find the cost of one tomato plant and the cost of one pepper plant.

You must show all your working.

Tomato plant \$ .....

Pepper plant \$ ..... [5]