



# Cambridge IGCSE™

CANDIDATE  
NAME

CENTRE  
NUMBER

--	--	--	--	--

CANDIDATE  
NUMBER

--	--	--	--

**MATHEMATICS**

**0580/43**

Paper 4 (Extended)

**October/November 2022**

**2 hours 30 minutes**

You must answer on the question paper.

You will need: Geometrical instruments

## INSTRUCTIONS

- Answer **all** questions.
- Use a black or dark blue pen. You may use an HB pencil for any diagrams or graphs.
- Write your name, centre number and candidate number in the boxes at the top of the page.
- Write your answer to each question in the space provided.
- Do **not** use an erasable pen or correction fluid.
- Do **not** write on any bar codes.
- You should use a calculator where appropriate.
- You may use tracing paper.
- You must show all necessary working clearly.
- Give non-exact numerical answers correct to 3 significant figures, or 1 decimal place for angles in degrees, unless a different level of accuracy is specified in the question.
- For  $\pi$ , use either your calculator value or 3.142.

## INFORMATION

- The total mark for this paper is 130.
- The number of marks for each question or part question is shown in brackets [ ].

This document has **20** pages. Any blank pages are indicated.



- 1 (a) Here are the ingredients needed to make a pasta bake to serve 12 people.

250g butter  
 600g pasta  
 460g mushrooms  
 280g cheese  
 800ml milk

- (i) Find the mass of the cheese as a percentage of the mass of the mushrooms.

..... % [1]

- (ii) Find the mass of butter needed to make a pasta bake to serve 18 people.

..... g [2]

- (iii) Monica has 2.2 litres of milk and 1.5 kg of each other ingredient.

Calculate the greatest number of people she can serve with pasta bake.

..... [3]

- (b) In 2019, a packet of pasta cost \$2.40.  
This was an increase of 25% of the cost of a packet in 2018.

(i) Work out the cost in 2018.

\$ ..... [2]

- (ii) In 2020, the cost of a packet increased by 15% from the cost in 2019.

Work out the total percentage increase in the cost of a packet from 2018 to 2020.

.....% [3]

(c)

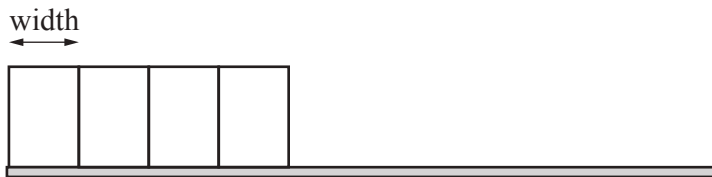

Pasta is sold in packets with width 11.5 cm, correct to the nearest 0.5 cm.  
A shop places these packets in a single line on a shelf of length 2 m, correct to the nearest 0.1 m.

Find the maximum number of these packets that will fit along this shelf.  
You must show all your working.

..... [3]

2 (a) Simplify fully.

(i)  $p^3 \times p^{11}$

..... [1]

(ii)  $\frac{18m^6}{3m^2}$

..... [2]

(iii)  $\left(\frac{27x^9y^{27}}{64}\right)^{-\frac{1}{3}}$

..... [3]

(b) A sequence has  $n$ th term  $3n^2$ .

Write down the first 3 terms of this sequence.

....., ....., ..... [2]

(c) Find the  $n$ th term for each of these sequences.

(i) 13, 16, 19, 22, 25, ...

..... [2]

(ii) 3, 17, 55, 129, 251, ...

..... [2]

(d) Solve.

$$\frac{3x-22}{4} = 23$$

$$x = \dots\dots\dots [3]$$

(e) Use the quadratic formula to solve  $3x^2 + 8x - 20 = 0$ .  
Show all your working and give your answers correct to 2 decimal places.

$$x = \dots\dots\dots, x = \dots\dots\dots [4]$$

- 3 The height,  $h$  cm, of each of 100 plants is recorded.  
The table shows information about the heights of these plants.

Height ( $h$ cm)	$10 < h \leq 15$	$15 < h \leq 25$	$25 < h \leq 40$	$40 < h \leq 60$	$60 < h \leq 70$
Frequency	8	18	28	33	13

- (a) Complete the histogram to show this information.  
The first two blocks have been drawn for you.

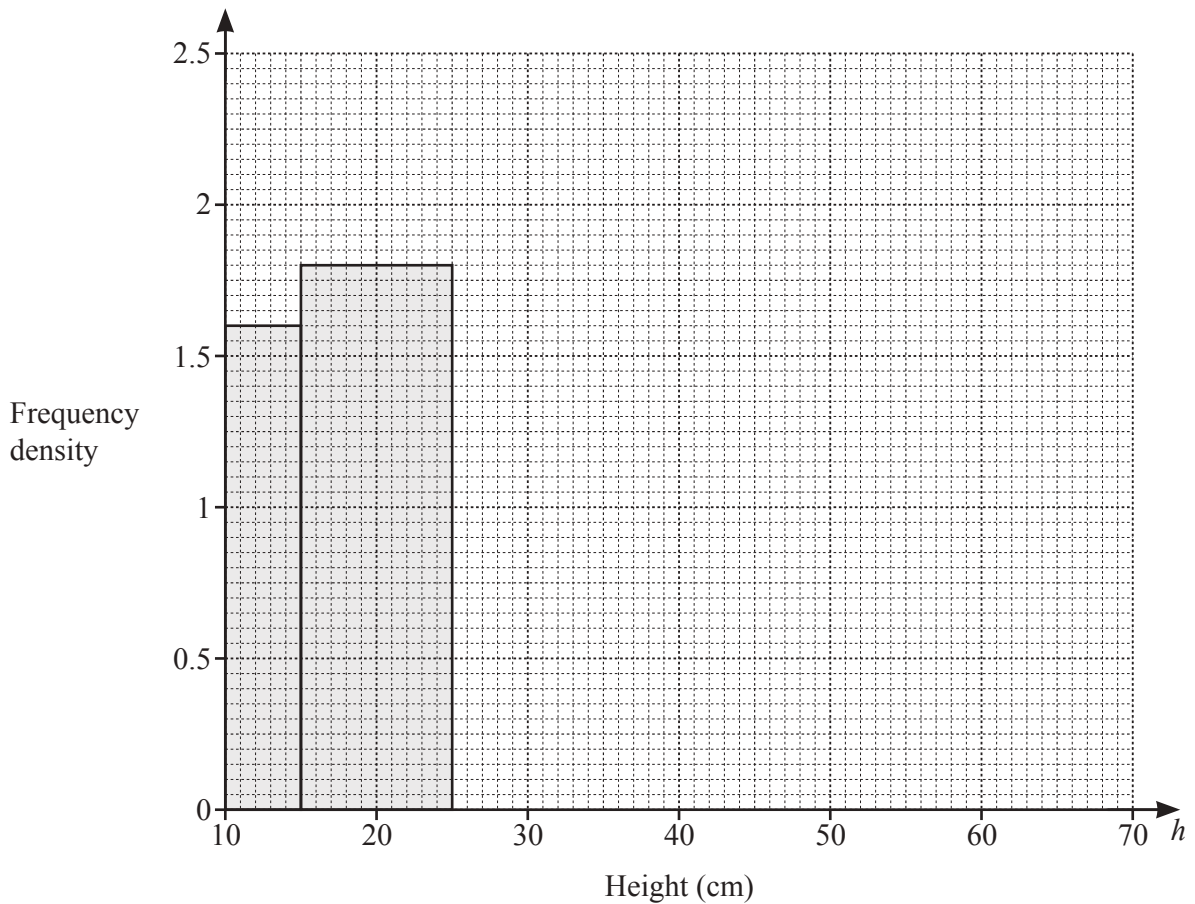

[3]

- (b) Calculate an estimate of the mean height.

..... cm [4]

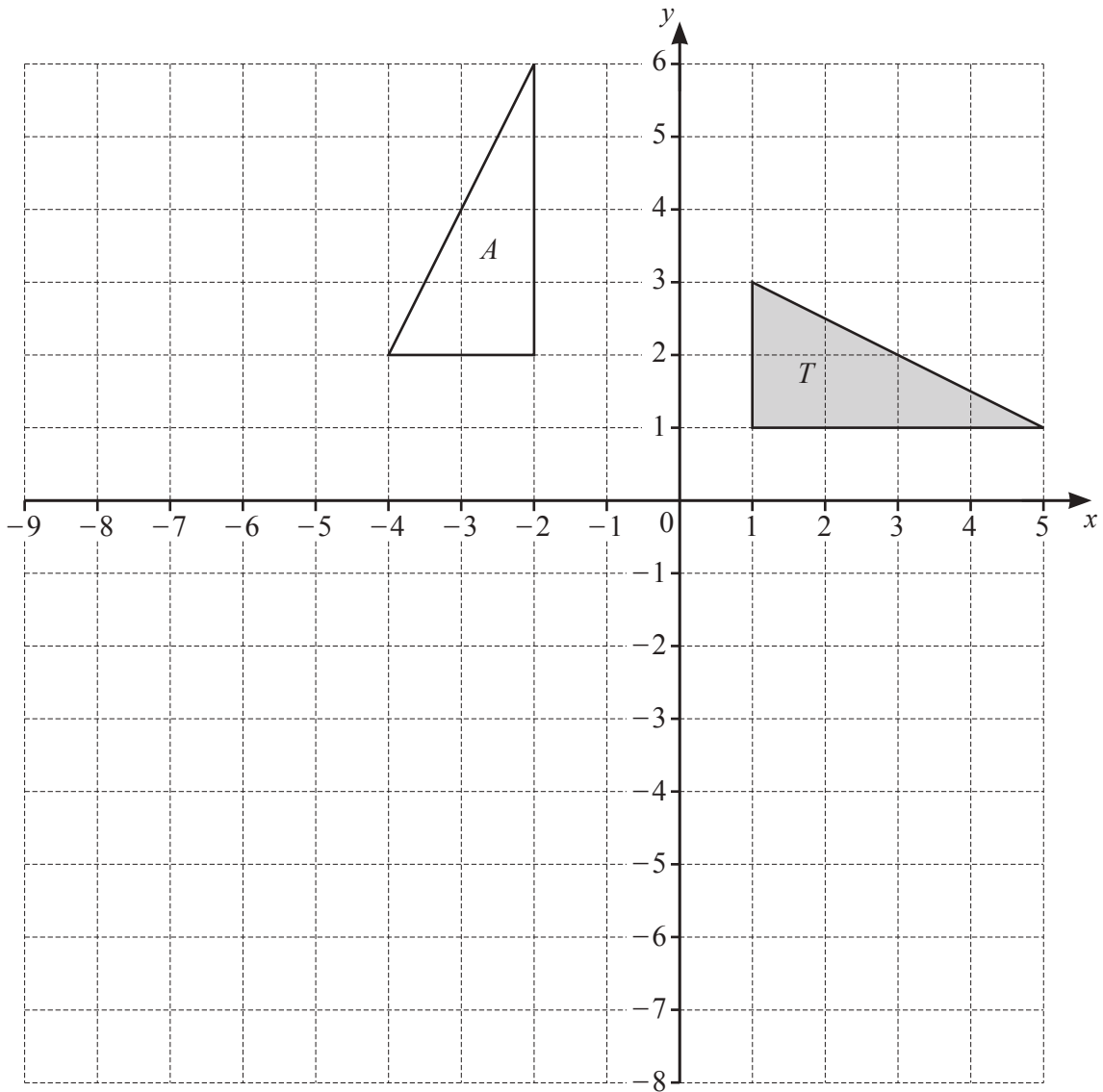

- (a) Draw the reflection of triangle  $T$  in the line  $y = -2$ . [2]
- (b) Draw the enlargement of triangle  $T$  with scale factor  $\frac{1}{2}$  and centre of enlargement  $(-5, -3)$ . [2]
- (c) Describe fully the **single** transformation that maps triangle  $T$  onto triangle  $A$ .

..... [3]

.....

5

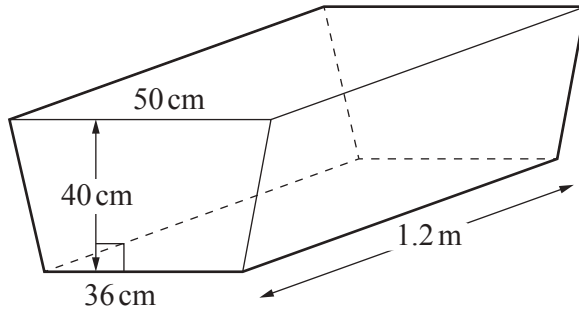

NOT TO SCALE

The diagram shows a water trough in the shape of a prism. The prism has a cross-section in the shape of an isosceles trapezium. The trough is completely filled with water.

(a) Show that the volume of water in the trough is 206.4 litres.

[3]

(b) The water from the trough is emptied at a rate of 600 ml per second.

Calculate the time taken, in minutes and seconds, for the trough to be emptied.

..... minutes ..... seconds [3]

(c) All the water from the trough is emptied into a vertical cylindrical tank. The depth of the water in the tank is 84 cm.



(i) Calculate the radius of the tank.

..... cm [3]



(ii) The tank is 60% full.

Calculate the height of the tank.

..... cm [2]

(d)

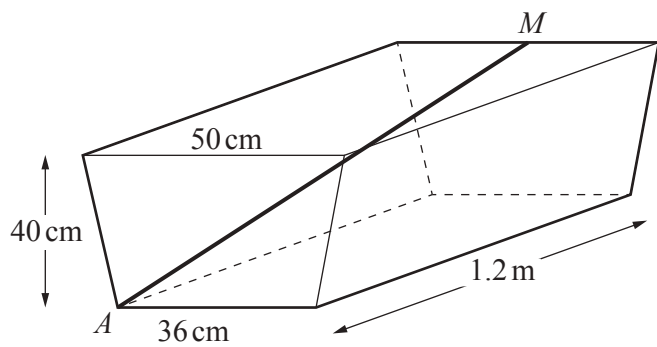

NOT TO SCALE

A steel rod  $AM$  is placed inside the empty water trough as shown in the diagram.  $A$  is a vertex at the base of the isosceles trapezium and  $M$  is the midpoint of the top edge on the opposite face.

Calculate the length of the steel rod,  $AM$ .

$AM =$  ..... cm [4]

6 (a)  $P = 5k^2 - 7$

(i) Find the value of  $P$  when  $k = 3$ .

$P = \dots\dots\dots$  [2]

(ii) Rearrange the formula to make  $k$  the subject.

$k = \dots\dots\dots$  [3]

(b) (i) Solve.

$$x - 3 \leq 5x + 7$$

$\dots\dots\dots$  [2]

(ii) Show your answer to **part (b)(i)** on the number line.

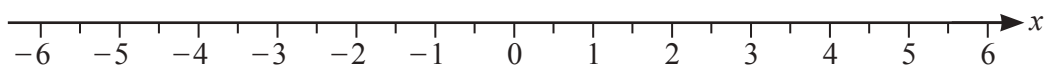

[1]

(c) The line  $y = 16$  is drawn on the grid.

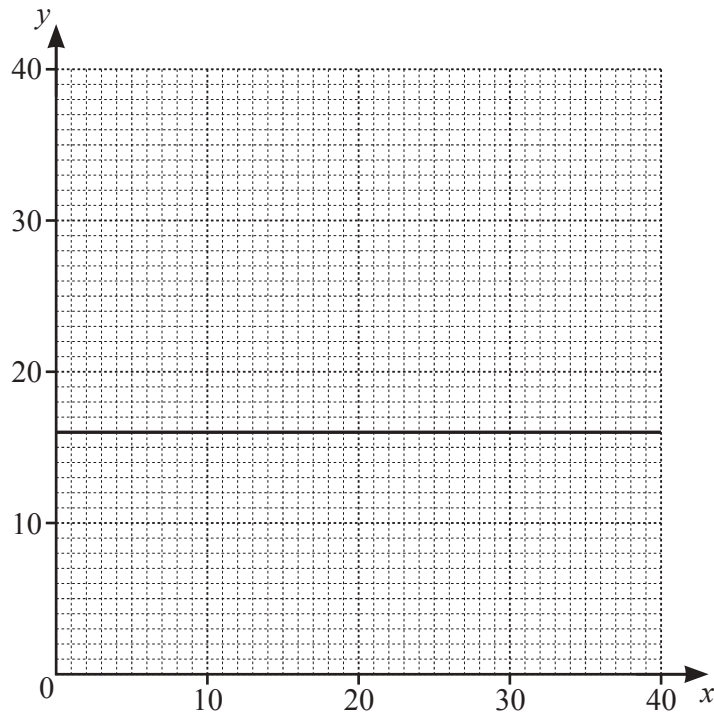

The region  $R$  satisfies the following inequalities.

$$y \geq 16 \quad x > 2 \quad 2x + 3y \geq 72 \quad y \leq 32 - x$$

- (i) By drawing three more lines and shading the region **not required**, find and label region  $R$ . [6]
- (ii) Find the integer coordinates  $(x, y)$  in the region  $R$  that give the maximum value of  $2x + y$ .

(..... , ..... ) [2]

7 Regan is playing a game with these six number cards.

-3
----

-2
----

2
---

3
---

5
---

7
---

- (a) She takes two cards at random, without replacement, and **multiplies** the two numbers to give a score.

Find the probability that

- (i) the score is 35

..... [3]

- (ii) the score is a positive number.

..... [3]

- (b) Regan now takes three cards at random from the six cards, without replacement, and **adds** the three numbers to give a total.

Find the probability that her total is 5.

..... [4]

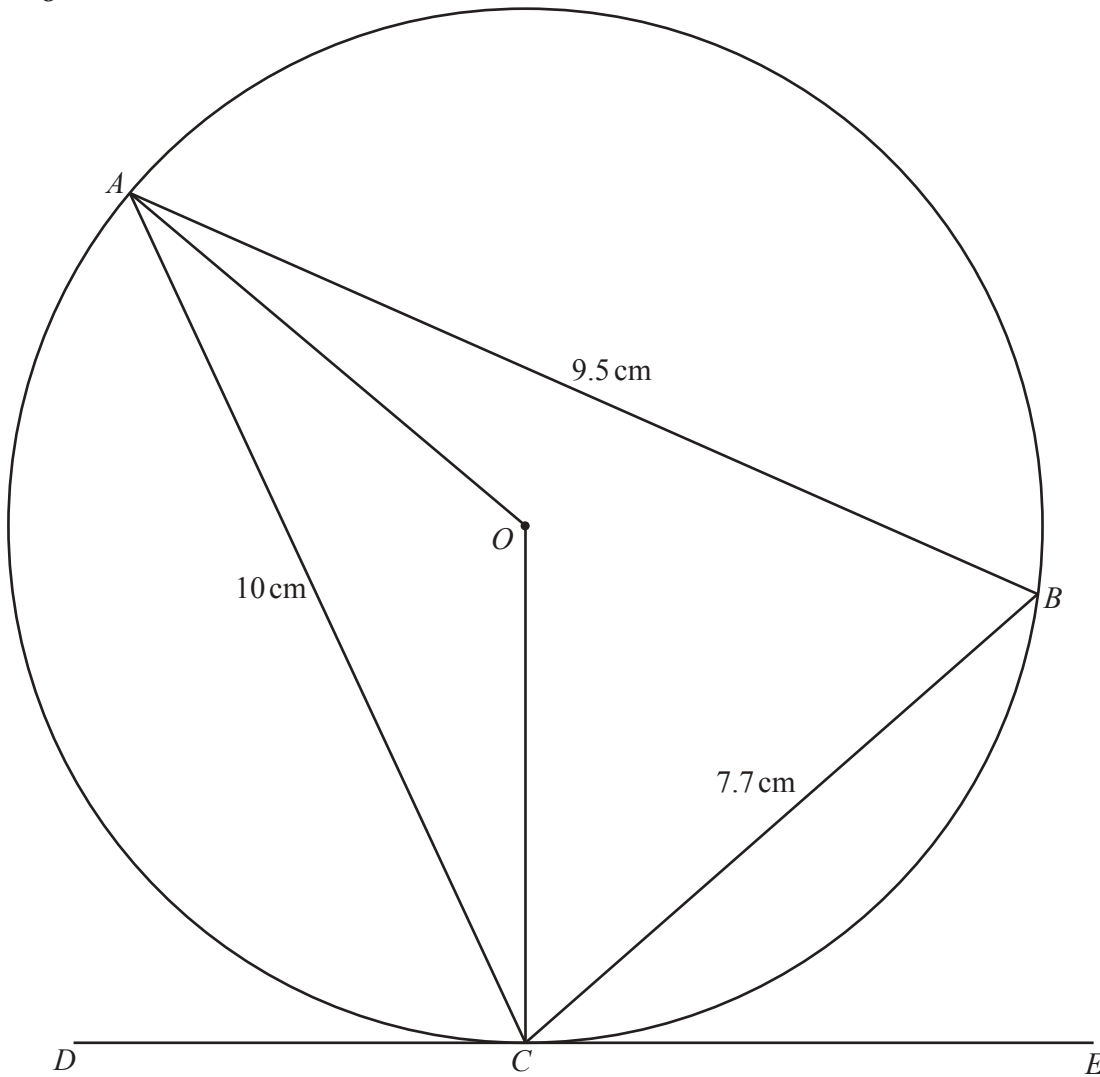

NOT TO  
SCALE

$A$ ,  $B$  and  $C$  are points on the circle, centre  $O$ .  
 $DE$  is a tangent to the circle at  $C$ .  
 $AC = 10$  cm,  $AB = 9.5$  cm and  $BC = 7.7$  cm.

(a) Show that angle  $ABC = 70.2^\circ$ , correct to 1 decimal place.

[4]

(b) Find

(i) angle  $AOC$

Angle  $AOC = \dots\dots\dots$  [1]

(ii) angle  $ACO$

Angle  $ACO = \dots\dots\dots$  [1]

(iii) angle  $ACD$ .

Angle  $ACD = \dots\dots\dots$  [1]

(c) Calculate the radius,  $OC$ , of the circle.

$OC = \dots\dots\dots$  cm [3]

(d) Calculate the area of triangle  $ABC$  as a percentage of the area of the circle.

$\dots\dots\dots$  % [4]

- 9 (a) Sketch the following graphs.  
On each sketch, indicate any intercepts with the axes.

(i)  $3x - 4y = 12$

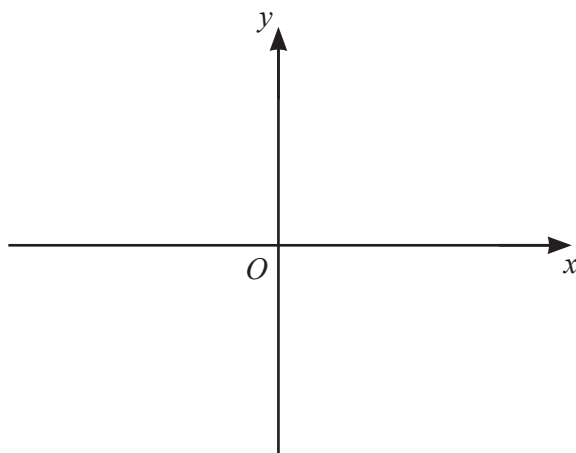

[2]

(ii)  $y = x^2 - 3x - 4$

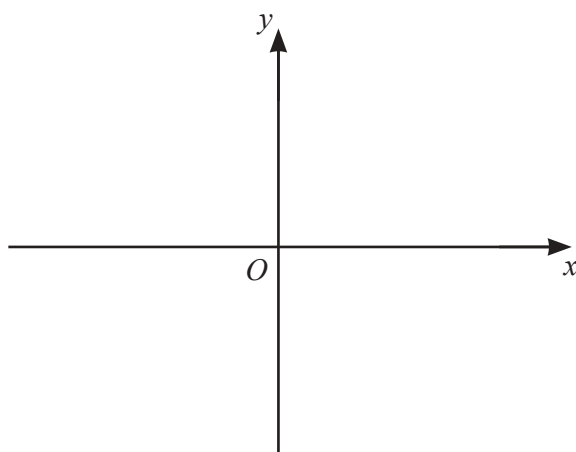

[4]

(iii)  $y = 6^x$

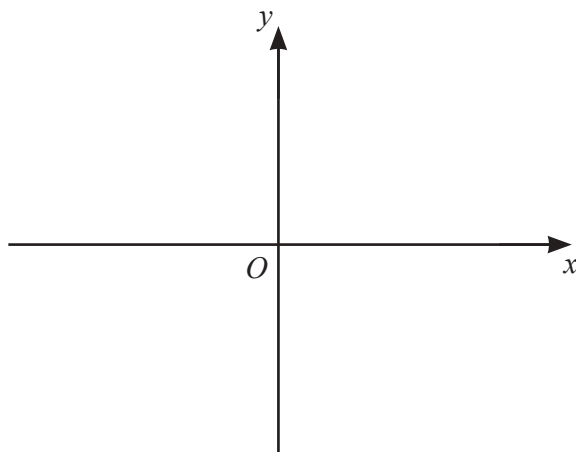

[2]



(b) (i) Find the derivative,  $\frac{dy}{dx}$ , of  $y = 5 + 8x - \frac{4}{3}x^3$ .

..... [2]

(ii) Find the gradient of  $y = 5 + 8x - \frac{4}{3}x^3$  at  $x = -1$ .

..... [2]

(iii) A tangent is drawn to the graph of  $y = 5 + 8x - \frac{4}{3}x^3$ .

The gradient of the tangent is  $-28$ .

Find the coordinates of the two possible points where this tangent meets the graph.

(..... , .....)

(..... , .....) [5]

10 (a)  $\mathbf{a} = \begin{pmatrix} 1 \\ 2 \end{pmatrix}$        $\mathbf{b} = \begin{pmatrix} -3 \\ 5 \end{pmatrix}$

(i) On the grid, draw and label vector  $2\mathbf{a}$ .

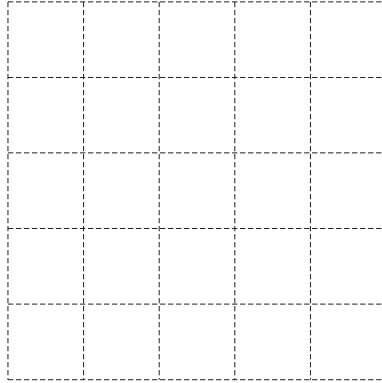

[1]

(ii) On the grid, draw and label vector  $(\mathbf{a} - \mathbf{b})$ .

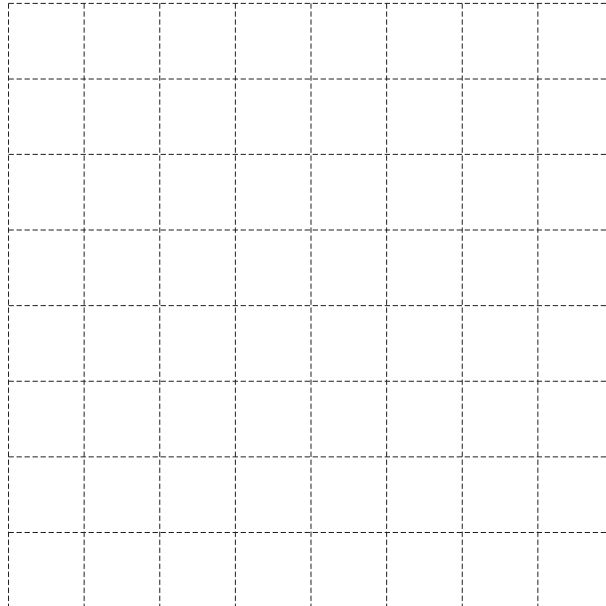

[2]

(b)

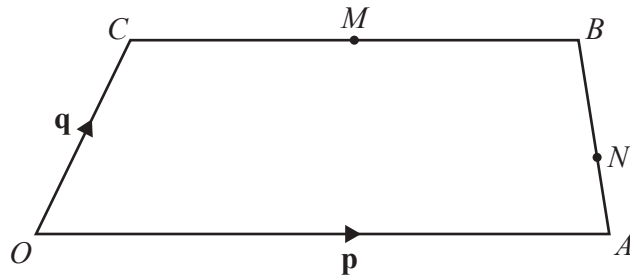

NOT TO SCALE

$OABC$  is a trapezium with  $OA$  parallel to  $CB$ .  
 $M$  is the midpoint of  $CB$  and  $N$  is the point on  $AB$  such that  $AN : NB = 1 : 2$ .  
 $O$  is the origin,  $\vec{OA} = \mathbf{p}$ ,  $\vec{OC} = \mathbf{q}$  and  $\vec{CB} = \frac{3}{4}\mathbf{p}$ .

(i) Find, in terms of  $\mathbf{p}$  and/or  $\mathbf{q}$ , in its simplest form

(a)  $\vec{OB}$

$\vec{OB} = \dots\dots\dots$  [1]

(b)  $\vec{AB}$

$\vec{AB} = \dots\dots\dots$  [2]

(c)  $\vec{MN}$ .

$\vec{MN} = \dots\dots\dots$  [3]

(ii)  $OA$  and  $MN$  are extended to meet at  $G$ .

Find the position vector of  $G$  in terms of  $\mathbf{p}$ .

$\dots\dots\dots$  [2]